



***Installation Manual for
SunEvo Solar PV Modules***

Table of Contents

Purpose of this guide	2
General Safety	
Handling Safety	
Installation Safety	
Fire Safety	
Product Identification	4
Mechanical Installation	5
Selecting a Location	
Before Installing	
General Installation	
Mounting Methods and Mechanical Loads	
Electrical Installation	14
General Electrical Connection	
Electrical Property	
Series Wiring and Parallel Wiring	
Grounding	
Maintenance	18

Purpose of this guide

This guide contains information regarding the installation and safe handling of SunEvo Solar Co., Ltd. (hereinafter referred to as "SunEvo") photovoltaic modules (hereinafter referred to as "PV modules" or "modules").

Installers must read and understand this guide prior to installation. For any questions, please contact SunEvo's Global Quality & Customer Support department or our local representatives for more detailed information. Installers must follow all safety precautions as described in this guide as well as local requirement and regulations by law or authorized organizations.

Before installing a solar photovoltaic system, installers should familiarize themselves with its mechanical and electrical requirements. Keep this guide in a safe place for future reference (care and maintenance) and in case of sale or disposal of the modules.

SunEvo modules are tested and certified for installation worldwide. Different regions may have different regulations for solar PV installations. In this guide, hereinafter "IEC Only" refers to regions where IEC standard applies, e.g. Europe, Middle East, most of Asia Pacific countries; "UL Only" refers to regions where UL standard applies, e.g. United States; all other references are global.

General Safety

Modules that fall under this application class may be used in system operation at more than 50V DC or 240W, where general contact access is anticipated. Modules complying with IEC 60417-5172 are considered to meet Class II ().

The environmental temperature in which the PV modules work is between -40°C and 40°C with relative humidity of less than 85%, while their operating temperature is from -40°C and 85°C .

PV modules are recommended to be installed at an altitude of less than 2000m.

Installing solar photovoltaic systems requires specialized skills and knowledge. Installation must only be performed by authorized and trained personnel.

Installers must assume all risks of injury that might occur during installation, including, but not limited to, the risk of electric shock.

One single module may generate more than 30V DC when exposed to direct sunlight. Contact with a DC voltage is potentially hazardous and should be always avoid.

Do not disconnect the modules or any electrical part under load.

PV modules generate electricity when exposed to sunlight. Number of modules string connected can cause lethal shock and burn hazards. Only authorized and trained person should have access to the modules.

Modules convert light energy to direct current electrical energy. They are designed for outdoor use. Modules can be ground mounted, mounted on rooftops. The responsibility of proper design of support structures lies in the system designers and installers.

When installing the system, abide to all local, regional and national statutory regulations. Obtain a building permit if necessary.

The electrical characteristics are within $\pm 3\%$ of the indicated values of I_{sc} , V_{oc} and P_{max} under standard test conditions (irradiance of 1000 W/m^2 , AM 1.5 spectrum, and a cell temperature of 25°C (77°F)).

Only use equipment, connectors, wiring and support frames suitable for solar electric systems.

Do not use mirrors, magnifiers or artificially concentrated sunlight onto the modules.

Always use fall protection equipment when working at a height of 6 feet (183cm) or above. Follow Occupational Safety and Health Act (OSHA) or local governing safety regulations regarding Fall Protection. (UL Only)

Do not sit, stand, step or walk on any side of the module, including the frames.

Do not permit any part of the module(s) to be submerged or allow for constant water to soil the module(s) unless it's natural rain fall or periodic cleaning.

Do not permit constant dew on any part of backsheet of the module.

The module is considered to be in compliance with this standard only when the module is either mounted in the manner specified by the mounting instructions, or when the mounting method has been evaluated with

this PV module to UL 2703. A module with exposed conductive parts is considered to be in compliance with this standard only when it is either electrically grounded in accordance with the manufacturer's instructions and the requirements of the National Electrical Code, ANSI/NFPA 70 (2014-2017), or when the bonding means has been evaluated with this PV module to UL 2703. (UL Only)

Handling Safety

Do not lift the module by holding the module's junction box or electrical leads.

Do not place any heavy or sharp objects on the module.

Be cautious when placing the module down onto a surface, particularly when placing it in a corner.

Inappropriate transport and installation may break the module and void the warranty.

Do not attempt to disassemble the modules, and do not remove any attached nameplates or components from the modules.

Do not apply paint or adhesive to the module top surface or backsheet.

To avoid damage to the backsheet and cells, do not scratch, dent or hit the backsheet. During the transportation, do not to apply direct pressure on the backsheet or front glass.

Do not drill holes in the frame. This may compromise the frame strength, cause corrosion of the frame and void the warranty.

Do not scratch the anodized coating of the frame (except for grounding connections at the grounding connection point on the back side of the module). It may cause corrosion of the frame or compromise the frame strength.

A module with broken glass or torn backsheet cannot be repaired and must not be used since contact with any module surface or the frame can cause an electric shock.

Work only under dry conditions, and use only dry tools. Do not handle modules under wet conditions unless wearing appropriate protective equipment.

When storing uninstalled modules outdoors for any period of time, always cover the modules and ensure that the glass faces down on a soft flat surface to prevent water from collecting inside the module and causing damage to exposed connectors.

Installation Safety

Never disconnect electrical connections or unplug connectors while the circuit is under load.

Contact with electrically active parts of the modules, such as terminals, can result in burns, sparks and lethal shock whether or not the module is connected.

Do not touch the PV module unnecessarily during installation. The glass surface and the frame may be hot; there is a risk of burns and electric shock.

Do not work in the rain, snow or in windy conditions.

Avoid exposing cables and connectors to direct sunlight and scratches or cuts in order to prevent insulation degradation.

Use only insulated tools that are approved for working on electrical installations.

Keep children well away from the system while transporting and installing mechanical and electrical components.

Completely cover the module with an opaque material during installation to prevent electricity from being generated.

Do not wear metallic rings, watchbands, earrings, nose rings, lip rings or other metallic objects while installing or troubleshooting photovoltaic systems.

Follow the safety regulations(e.g., safety rules for working on electrical power plant stations) of your regions and for all other system components, including wires and cables, connectors, charging regulators, inverters, storage batteries, rechargeable batteries, etc.

Under normal conditions, a photovoltaic module is likely to experience conditions that produce more current and/or voltage than reported at standard test conditions. Accordingly, the values of I_{sc} and V_{oc} marked on this module should be multiplied by a factor of 1.25 when determining component voltage ratings, conductor current ratings, minimum factor of fuse sizes, and size of controls connected to the PV output.

Only use same connectors to connect modules to form a string, or connect to another device. Removing the connectors will void the warranty.

Fire Safety

Consult your local authority for guidelines and requirements for building or structural fire safety.

Roof constructions and installations may affect the fire safety of a building; improper installation may create hazards in the event of a fire.

Use components such as ground fault circuit breakers and fuses as required by local authority.

Do not use modules near equipment or in places where flammable gases may be generated.

Modules rated for Module Fire Performance Type I must be installed on a roof which has appropriate fire resistance. Before mounting on the roof, please consult your local building related department to make sure the approved roofing materials. The module qualified for safety through UL 61730 within this application class are considered to meet the requirement of Safety Class II. (UL only)

A minimum slope of 5 in/ft. for installation on a roof is required to maintain the fire class ratings. Any module or panel mounting system have limitations on inclination required to maintain a specific System Fire Class Rating. (UL only)

Product identification

Each module has two labels providing the following information:

Nameplate: describes model number; electrical properties like rated power, rated current, rated voltage, open circuit voltage, short circuit current etc., mechanical properties like weight, dimensions etc., certification information, company information as well as product origin.

Barcode: each individual module has a unique serial number. Each module has only one bar code. It is permanently attached to the interior of the module and is visible from the top front of the module. This bar code is inserted prior to laminating.

Mechanical Installation

Selecting a location

Select a suitable location for installing the modules.

The modules should face south in northern latitudes and north in southern latitudes.

For detailed information on the best installation angle, refer to standard solar photovoltaic installation guides or consult a reputable solar installer or systems integrator.

Modules should not be shaded at any time. If a module is shaded or even partially shaded, it will fail to perform at ideal conditions and result in lower power output. A permanent and/or regular shade on the module voids the warranty.

Do not use modules near equipment or in locations where flammable gases may be generated or collected.

Before Installing

Before installing modules check for any optical deviations. Any optical deviations noticed after system installed may cause the warranty invalid. Any potential costs for labor, material or other cost such as documentation, safety or performing the (de/ re-) installation will not be covered.

The module mounting structure must be made of durable, corrosion-resistant and UV-resistant material. Always use a tested and certified mounting structure approved for your system design.

In regions with heavy snowfall in winter, adjust the height of the mounting system so that the lower edge of the module is not covered by snow. In addition, ensure the lower part of the module is not in the shadow of plants, trees or damaged by ground soil moved by or through the air.

For ground mounting systems, the minimum distance recommends from the ground to the lower edge of the module is at least 24 inches (60cm).

Modules must be securely attached to the mounting structure. For Clamping System installation methods, the recommended maximum compression for each clamp is 2900 PSI (20 Mpa) in order to avoid potential damages to module frames. Follow the instruction of the clamping system supplier.

Provide adequate ventilation under the modules in conformity to your local regulations. A minimum distance of 10 cm between the roof plane and the frame of the module is generally recommended.

Always observe the instructions and safety precautions included in the module support frames.

Before installing modules on a roof, always ensure the roof construction is suitable. In addition, any roof penetration required to mount the module must be properly sealed to prevent leaks.

Dust built up on the surface of the module can impair with the module performance. The modules shall be installed with a tilt angle no less than 10 degrees, making it easier for dust to be removed by rain. A flat angle requires more frequent cleaning.

Observe and take into account the linear thermal expansion of the module frames (the recommended minimum distance between two modules is 2 cm).

Always keep the front and backsheets of the module free from foreign objects, plants and vegetation, structural elements, which could come into contact with the module, especially when the module is under mechanical load.

When installing a module on a pole, select a pole and module mounting structure robust enough to withstand the anticipated wind load and snow load in the area.

Ensure modules are not exposed to wind or snow load exceeding the maximum permitted values, and are not exposed to excessive forces due to the thermal expansion of support structures. Never allow modules overlap or exceeds the rooftop: Refer to the following mounting methods for more detailed information.

General Installation

Modules can be installed by using mounting holes, clamps* or an insertion system, recommended torque is 20Nm-25Nm. Modules must be installed according to the following examples. Strictly follow the guidelines when installing, otherwise the warranty will be affected.

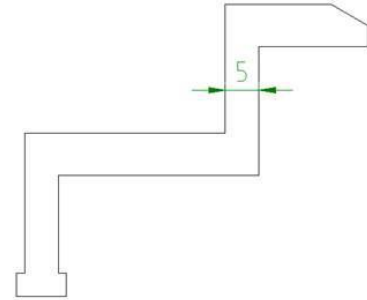
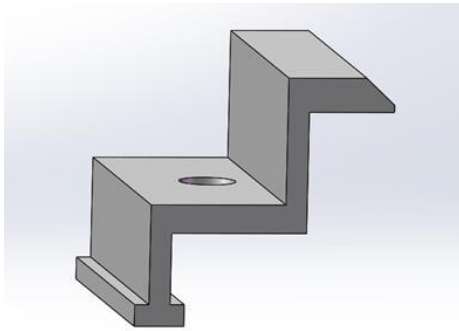
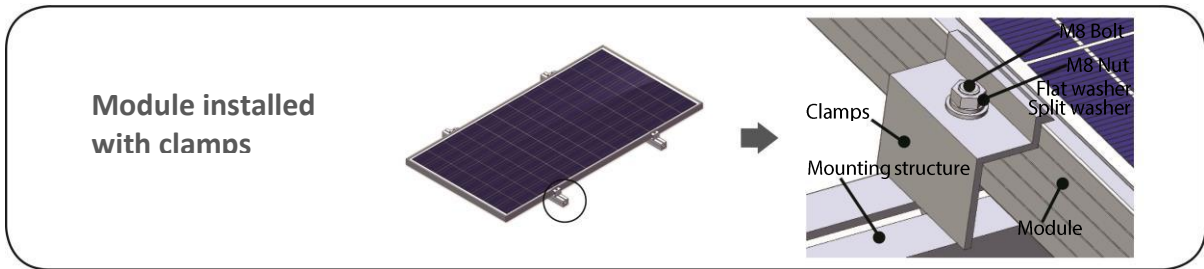
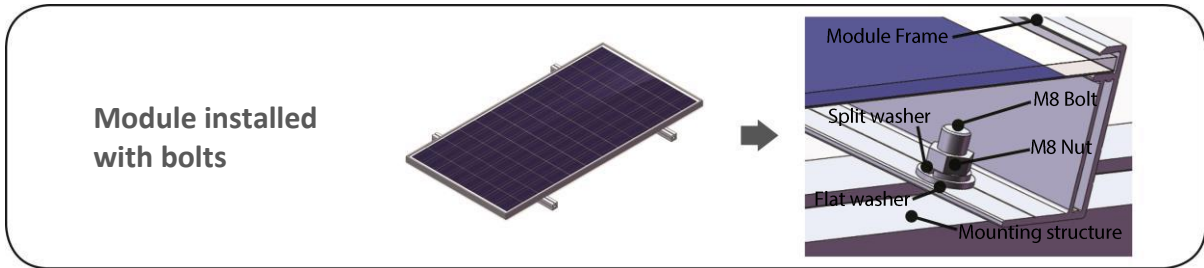

* The required length for each clamp is minimum 50 mm, and wall thickness of its upper part is no less than 5mm

Module can be installed in both landscape and portrait modes.

The modules must be properly secured to their support so that they can withstand positive and negative load they have been certified for. Installer must ensure that the clamps used to secure the modules are robust enough.

Mounting Methods and Mechanical Loads

Select a proper installation method based on the required load (See below for more detailed information).

All installation methods herein are only for reference, and SunEvo will not provide related mounting components. The system installer or trained professional personnel must be responsible for the PV system's design, installation, and mechanical load calculation and security of the system.

For each installation, modules can be installed either in portrait or landscape mode. If you integrate our obsolete products and need advice, please contact SunEvo Global Customer Service department for installation instructions.

SunEvo Standard Module Type (using 156.75 mm solar cell)	Module Dimension Length × Width × Thickness
SE2-60 Series (Full cell solar module)	1640mm × 992mm × 35mm 1650mm × 992mm × 35mm
SE2-72 Series (Full cell solar module)	1956mm × 992mm × 40mm 1960mm × 992mm × 40mm
SE2-60H Series(Half cell solar module)	1670mm × 992mm × 35mm
SE2-72H Series(Half cell solar module)	1988mm × 992mm × 40mm

SunEvo Standard Module Type (using 158.75 mm solar cell)	Module Dimension Length × Width × Thickness
SE3-60H Series (Half cell solar module)	1680mm × 1002mm × 35mm
SE3-72H Series (Half cell solar module)	2008mm × 1002mm × 35mm

SunEvo Standard Module Type (using 166 mm solar cell)	Module Dimension Length × Width × Thickness
SE4-60H Series (Half cell solar module)	1755mm × 1038mm × 35mm
SE4-72H(BD) Series (Half cell solar module)	2094mm × 1038mm × 35mm

SunEvo Standard Module Type (using 182 mm solar cell)	Module Dimension Length × Width × Thickness
SE5-54H Series (Half cell solar module)	1724mm × 1134mm × 35(30)mm 1722mm × 1134mm × 30mm
SE5-72H Series (Half cell solar module)	2279mm × 1134mm × 35mm 2278mm × 1134mm × 35mm
SE5-72HBD Series (Half cell solar module)	2279mm × 1134mm × 35(30)mm 2278mm × 1134mm × 30mm

SunEvo Standard Module Type (using 210 mm solar cell)	Module Dimension Length × Width × Thickness
SE6-66H(BD) Series (Half cell solar module)	2384mm × 1303mm × 35mm
SE6-60H(BD) Series (Half cell solar module)	2172mm × 1303mm × 35mm

Recommended mounting method

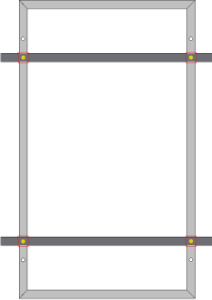
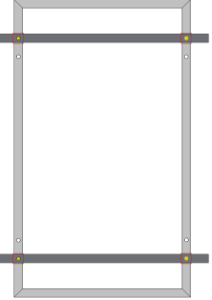
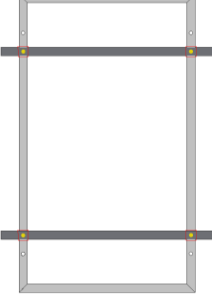
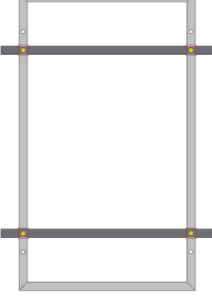
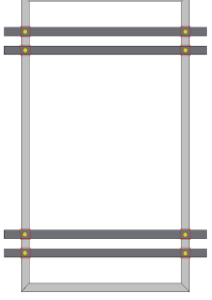

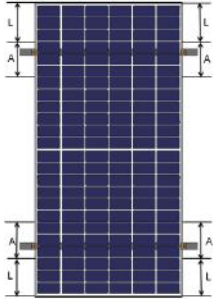
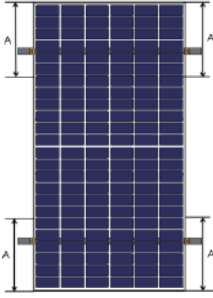
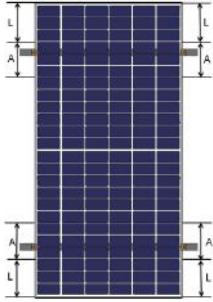
Mounting method*	Mechanical load	Installation location	Module type
Four bolts mounting with beams underneath	Test load: Positive 5400Pa Negative 2400Pa Safety factor: 1.5		SE2-60 Series SE2-60H Series SE3-60H Series SE4-60H Series SE5-54H Series(35mm & 30mm)**
Four bolts mounting with beams underneath	Test load: positive 3800Pa negative 2400Pa Safety factor: 1.5		SE2-60 Series SE2-60H Series SE3-60H Series SE4-60H Series SE5-54H Series(35mm & 30mm)**
Four bolts mounting with beams underneath	Test load: positive 5400Pa negative 3800Pa Safety factor: 1.5		SE2-72H Series
Four bolts mounting with beams underneath	Test load: positive 5400Pa negative 2400Pa Safety factor: 1.5		SE2-72H Series SE3-72H Series SE3-72H Series SE4-72H(BD) Series SE5-72H(BD) Series SE6-66H(BD) Series SE3-60H(BD) Series
Eight bolts mounting with beams underneath	Test load: positive 5400Pa negative 3800Pa Safety factor: 1.5		SE2-60 Series SE2-60H Series SE3-60H Series SE4-60H Series SE5-54H Series

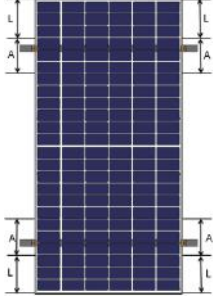
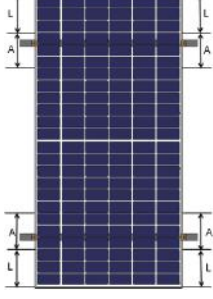
<p>Four clamps mounting with beams underneath</p>	<p>Test load: positive 6000Pa negative 3800Pa Safety factor: 1.5</p>	 <p>L = 200mm Clamping zone: A = 200 mm</p>	<p>SE5-54H Series (35mm & 30mm)</p>
<p>Four clamps mounting with beams underneath</p>	<p>Test load: positive 2400Pa negative 2400Pa Safety factor: 1.5</p>	 <p>Clamping zone: A = 1/4 long frame length±50 mm</p>	<p>SE2-60 Series SE2-72 Series SE2-60H Series SE3-60H Series SE4-60H Series SE5-54H Series (35mm & 30mm)</p>
<p>Four clamps mounting with beams underneath</p>	<p>Test load: positive 5400Pa negative 3800Pa Safety factor: 1.5</p>	 <p>SE2-72 Series L = 280 mm Clamping zone: A = 300 mm</p>	<p>SE2-60 Series SE2-72 Series</p>



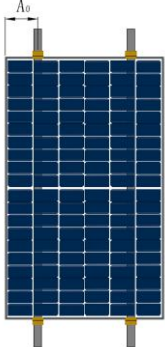

<p>Four clamps mounting with beams underneath</p>	<p>Test load: positive 5400Pa negative 3800Pa Safety factor: 1.5</p>	 <p>SE2-72H Series L = 300 mm SE3-60H Series L = 200 mm SE4-60H Series L = 200 mm SE3-72H Series L = 300 mm SE4-72H(BD) Series L = 380 mm Clamping zone: A = 200 mm</p>	<p>SE2-60H Series SE2-72H Series SE3-60H Series SE4-60H Series SE3-72H Series SE4-72H(BD) Series (35mm)</p>
<p>Four clamps mounting with beams underneath</p>	<p>Test load: positive 5400Pa negative 2400Pa Safety factor: 1.5</p>	 <p>SE5-72H Series L = 400 mm, clamping zone A = 250 mm SE6-66H(BD) Series L = 430 mm, clamping zone A = 160 mm SE6-60H(BD) Series L = 400 mm, clamping zone A = 160 mm SE4-72H(BD) Series L = 380 mm, clamping zone A = 200 mm SE5-72H(BD) Series L = 400 mm, clamping zone A = 250 mm</p>	<p>SE5-72H Series SE6-66H(BD) Series SE6-60H(BD) Series SE4-72H(BD) Series (30mm) SE5-72H(BD) Series (30mm)</p>

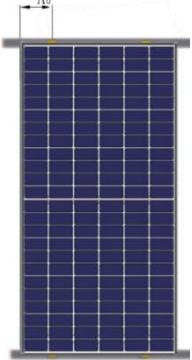
Customized mounting method

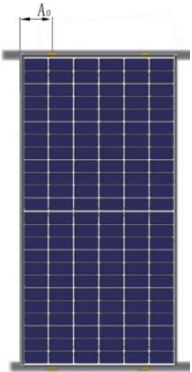
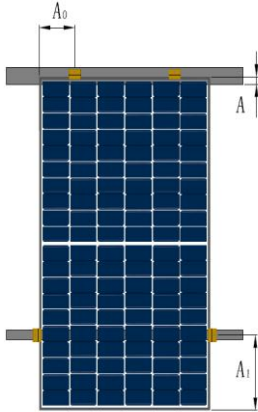
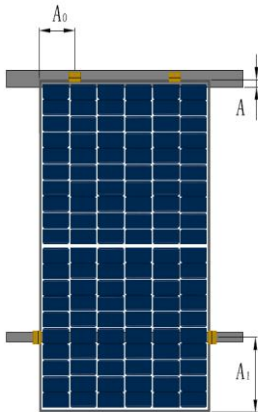
Note: The installation methods below are based on the internal evaluation results in SunEvo

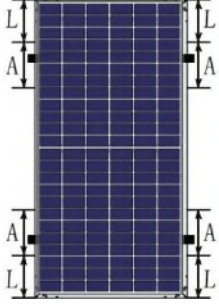
Mounting method*	Mechanical load	Installation location	Module type
Four clamps short end mounting with beams parallel with long frame	Test load: positive 5400Pa negative 2400Pa Safety factor: 1.5	 <p>$A_0 = 1/4 \text{ short frame length} \pm 50\text{mm}$</p>	SE4-60H Series SE5-54H Series (30mm & 35mm)
Four clamps short end mounting with beams parallel with long frame	Test load: positive 2400Pa negative 1600Pa Safety factor: 1.5	 <p>$A_0 = 1/4 \text{ short frame length} \pm 50\text{mm}$</p>	SE4-72H(BD) Series
Four clamps short end mounting with beams parallel with long frame	Test load: positive 2400Pa negative 800Pa Safety factor: 1.5	 <p>$A_0 = 1/4 \text{ short frame length} \pm 50\text{mm}$</p>	SE5-72H(BD) Series
Four clamps short end mounting with beams underneath the short frame	Test load: positive 2400Pa negative 2400Pa Safety factor: 1.5	 <p>$A_0 = 1/4 \text{ short frame length} \pm 50\text{mm}$</p>	SE5-54H5 Series (30mm)

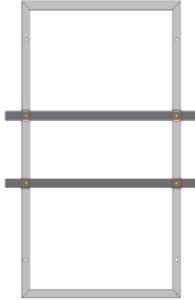
<p>Four clamps short end mounting with beams underneath the short frame</p>	<p>Test load: positive 1600Pa negative 1000Pa Safety factor: 1.5</p>	 <p>$A_0 = 1/4 \text{ short frame length} \pm 50\text{mm}$</p>	<p>SE4-72H(BD) Series</p>
<p>Four clamps mixed mounting with beams underneath</p>	<p>Test load: positive 2400Pa negative 2400Pa Safety factor: 1.5</p>	 <p>$A \geq 40\text{mm};$ $A_0 = 1/4 \text{ short frame length} \pm 50\text{mm};$ For SE3-72H Series, $A_1 = 360 \sim 560\text{mm}$ For SE4-60H and SE5-54H Series, $A_1 = 280 \sim 420\text{mm}$</p>	<p>SE3-72H Series SE4-60H Series SE5-54H Series (30mm & 35mm)</p>
<p>Four clamps mixed mounting with beams underneath</p>	<p>Test load: positive 1600Pa negative 1000Pa Safety factor: 1.5</p>	 <p>$A \geq 40\text{mm};$ $A_0 = 1/4 \text{ short frame length} \pm 50\text{mm};$ $A_1 = 360 \sim 560\text{mm}$</p>	<p>SE4-72H(BD) Series</p>

<p>Four clamps mounting without beams</p>	<p>Test load: positive 5400Pa negative 2400Pa Safety factor: 1.5</p>	 <p>L = 380 mm, clamping zone A = 200 mm</p>	<p>SE4-72H(BD) Series (35mm & 30mm) SE5-72H(BD) Series (35mm & 30mm)</p>
<p>Four bolts mounting without beams</p>	<p>Test load: positive 5400Pa negative 2400Pa Safety factor: 1.5</p>		<p>SE4-72H(BD) Series (35mm & 30mm) SE5-72H(BD) Series (35mm & 30mm)</p>
<p>Four bolts mounting without beams</p>	<p>Test load: positive 4500Pa negative 2400Pa Safety factor: 1.5</p>		<p>SE4-72H(BD) Series (35mm & 30mm)</p>
<p>Four bolts tracker mounting***</p>	<p>Test load: positive 1600Pa negative 1600Pa Safety factor: 1.5</p>		<p>SE4-72H(BD) Series (35mm & 30mm) SE5-72H(BD) Series (35mm & 30mm)</p>
<p>Short frame insertion / Slide-in</p>	<p>Test load: positive 2400Pa negative 2400Pa Safety factor: 1.5</p>		<p>SE2-60 Series SE3-60H Series SE4-60H Series SE5-54H Series (35mm & 30mm)</p>

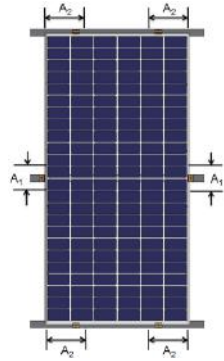
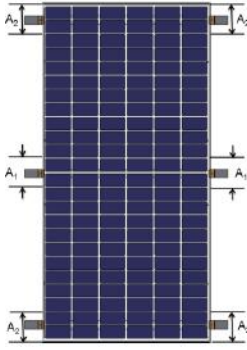
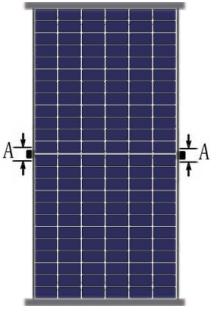
<p>Six clamps mounting with beams underneath</p>	<p>Test load: positive 5400Pa negative 3800Pa Safety factor: 1.5</p>	 <p>Clamping zone: $A_0 = 1/4$ short frame length ± 50 mm $A_1 = 100$ mm</p>	<p>SE2-60 Series SE2-72 Series SE2-60H Series SE2-72H Series SE3-60H Series SE4-60H Series SE5-54H Series (30mm & 35mm) SE5-72H Series</p>
<p>Six clamps mounting with beams underneath</p>	<p>Test load: positive 5400Pa negative 3800Pa Safety factor: 1.5</p>	 <p>Clamping zone: $A_1 = 100$ mm $A_2 = 200$ mm</p>	<p>SE2-60 Series SE2-72 Series SE2-60H Series SE2-72H Series SE3-60H Series SE4-60H Series SE3-72H Series SE4-72H Series SE5-54H Series (30mm & 35mm) SE5-72H Series</p>
<p>Insertion installation with two clamps in the middle</p>	<p>Test load: positive 5400Pa negative 3800Pa Safety factor: 1.5</p>	 <p>Clamping zone A = 100mm</p>	<p>SE2-60 Series SE2-60H Series SE3-60H Series SE4-60H Series SE2-72H Series SE4-72H Series SE5-72H Series</p>

* The module clamps must not come into contact with the front glass or deform the frame in any way. Avoid shading effects caused by clamps or insertion systems. Drainage holes in the module frame must not be closed or obscured by the clamps;

** 35mm or 30mm represents the height of frame;

*** The mounting holes reserved for tracker mounting system with special accessories. If the length of module is over 2 meters, its mechanical load value for tracker needs to be confirmed by module supplier

Electrical Installation

General Electrical Connection

Any hardware used must be compatible with any other used material to avoid galvanic corrosion. Defects caused by corrossions void the warranty.

It is not recommended to use modules with different configurations (grounding, wiring) in the same system.

Excessive cables must be organized or fixed in an adequate way, e.g. attached to the mounting structure by using non-metallic cable ties. Solar cables, connectors and junction boxes should not be exposed to water, snow, or rain or water submersion for a long period of time (IP65/67/68).

For applications requiring high operating voltage several modules can be connected in series to form a string of modules; the system voltage is then equal to the sum of the voltage of each module.

For applications requiring high operating currents several strings of modules can be connected in parallel; the system current is then equal to the sum of the current of each string of modules.

The maximum system voltage is 600 volts, 1000 volts or 1500 volts depending on the product family DC according to standards. The maximum number of series connected modules depends on system design, the type of inverter used and environmental conditions.

Based on the maximum series fuse rating of module and local electrical installation code, always make sure SunEvo PV modules are assembled with the appropriate string fuse for circuit protection.

There is no specific limitation on the number of modules that can be connected in parallel, the number of modules is determined by system design parameters such as current or power output.

To prevent the cables and the connectors from overheating, the cross section of the cables and the capacity of the connectors must be selected to suit the maximum system short circuit current. The recommended cable is PV wire with a cross section of at least 4mm².

Caution: do not secure the cables too tight. Any cable damage caused by cable management system is not covered under Suntech's warranty.

Always refer to the cable manufacturer's bending radius which includes the radius just behind the connectors.

When designing large modules arrays connected to a single inverter, always take into account the resulting isolation resistance (Riso), which decreases increasing the number of modules in the array. A too low Riso can result in inverter faults. Please refer to local regulations to determine the system wires size, type and temperature.

SunEvo modules come with connectors used for system electrical connections. The recommended connectors are STP-XC4, TL-CABLE01S, MC4, and Amphenol H4. SunEvo strongly recommends using the genuine connector type specified by Suntech's product data sheet. Choosing a different connector type other than specified may cause the warranty invalid.

To ensure reliable electric connection and to prevent possible intrusion of humidity, two connectors must be mated and locked together until a click can be heard.

Long-term exposure to wet environments may cause connectors' poor connectivity, resulting in current leakage and poor conductivity which voids the warranty. SunEvo recommends proper connector/cable/wire management to prevent moisture intrusion. Depending on the amount of humidity, SunEvo recommends periodic inspections of the installation system to maintain optimal module performance.

The DC current generated by photovoltaic systems can be converted into AC and fed into a public Grid. As local utilities' policies on connecting renewable energy systems to the Grids vary from region to region. Always seek the advice from a qualified system designer or integrator. Building permits, inspections and approvals by the local utility are generally required.

Especially for larger installations SunEvo recommends lightning protection following the local requirements and regulations.

When the installation finished and after connecting to the grid, please do a professional hand over to the owner including an installation protocol is required. Provide a clear documentation of the system to the owner consisting of following minimum data such as: user guide, system layout, data sheets, performance expectations, electrical system data e.g. a copy of the installation test report following minimum requirements of IEC 62446 / IEC 60364-6.

Electrical property

Module under standard test conditions of: irradiance of 1000W /m², cell temperature of 25 °C and air mass of AM1.5.

Normally, a module is likely to produce more current and/or voltage than reported at standard test conditions.. Accordingly, the values of I_{sc} and V_{oc} marked on this module should be multiplied by a factor of 1.25 when determining component voltage ratings, conductor ampacities, fuse sizes, and size of controls connected to the PV output.

Voltages are additive when modules are connected in series, and modules currents are additive when Modules are connected in parallel, as illustrated in Figure 1.

Modules with different electrical characteristics must not be connected directly in series.

Series Wiring and Parallel Wiring

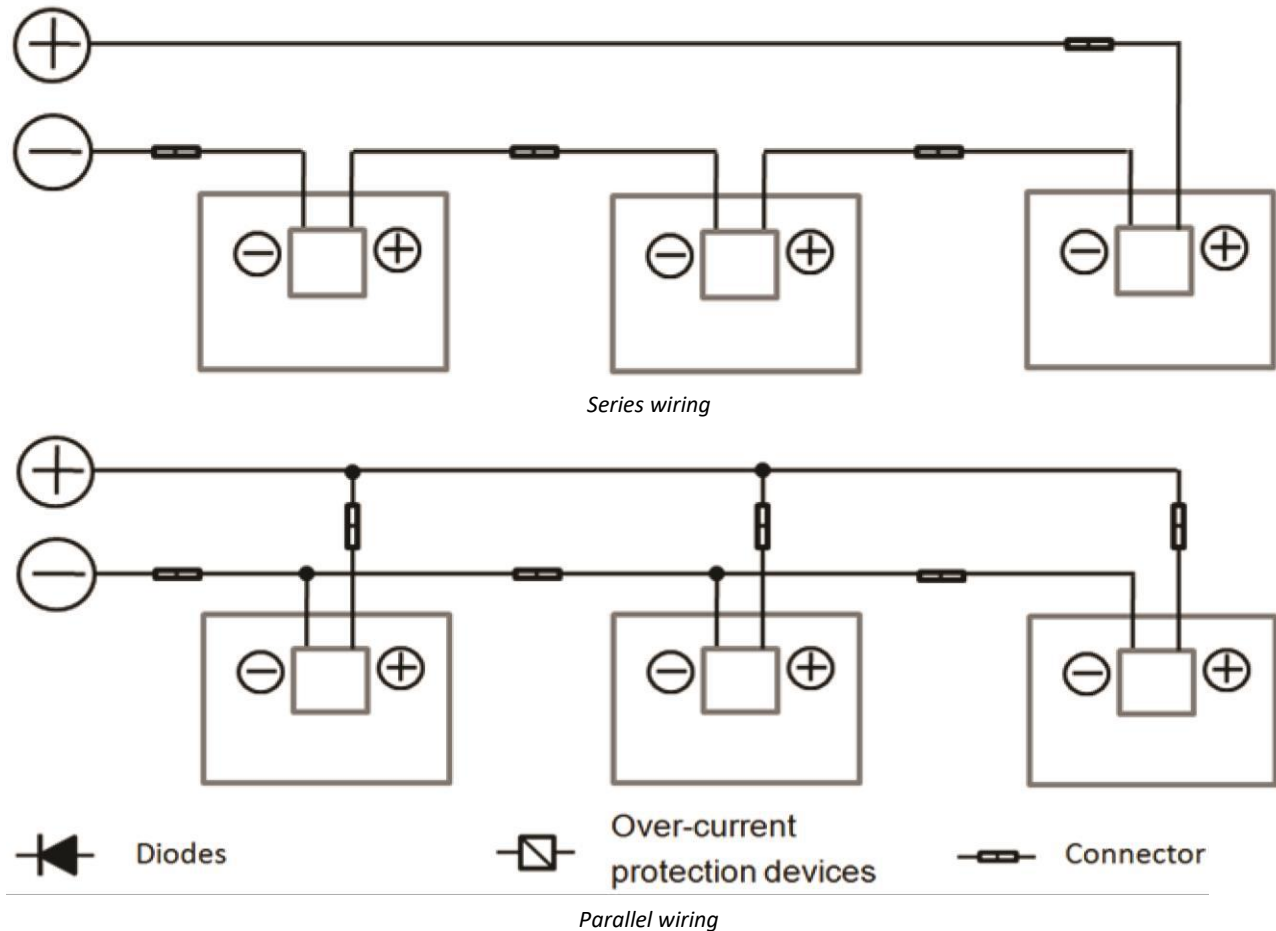

The maximum number of Modules that can be connected in series within a string must be calculated in accordance with applicable regulations in a way that the specified maximum system voltage of the modules and all other electrical DC components will not exceed in open-circuit operation at the lowest temperature expected at the PV system location.

Recommended maximum series configuration: $\text{system voltage} / (1.25 * V_{oc})$

Recommended maximum parallel configuration: $\text{overcurrent rating} / (I_{sc} + 1)$

Recommended installation method of full cell solar module:

The modules in PV array are recommended for portrait connecting, and cable length is not less than 0.7 m.

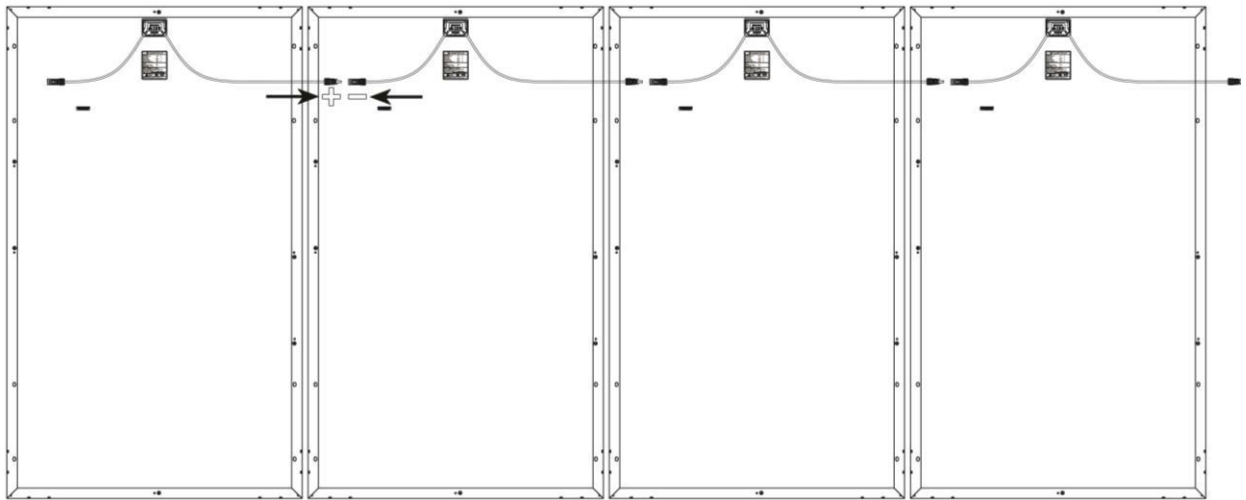

Recommended mounting method of half cell solar module:

The head and tail of the modules in PV array are placed in portrait layout, and cable length is not less than 0.65 m.

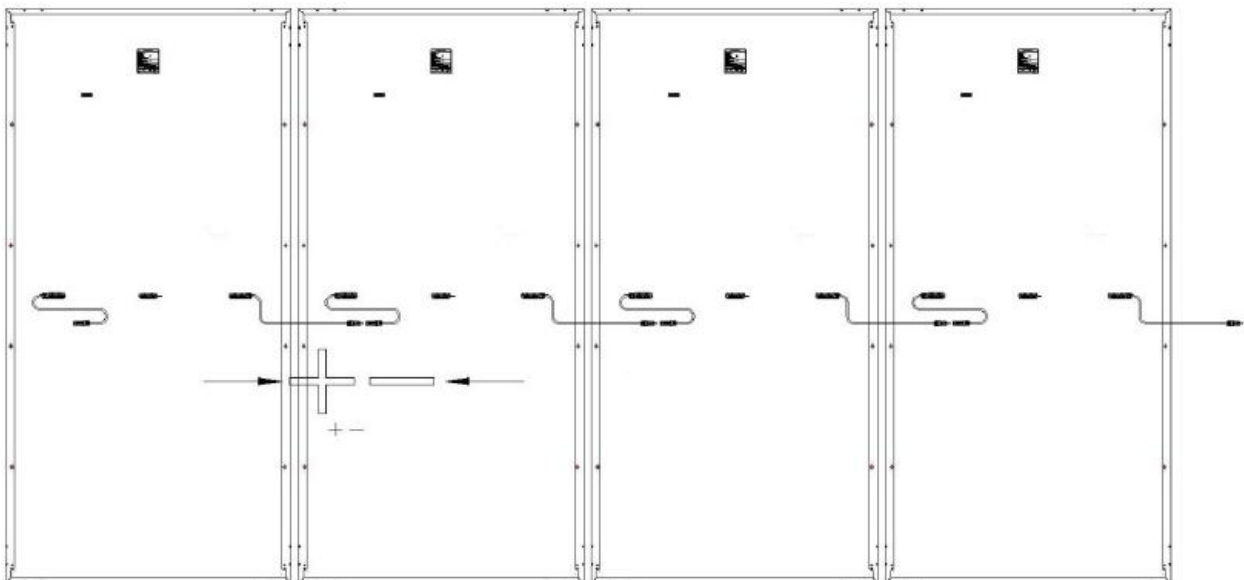

Grounding

For grounding and bonding requirements, please refer to regional and national safety and electricity standards. If grounding is required, use a recommended connector type for the grounding wire.

For grounding, this guide refers to module frame grounding. If grounding is required, make sure module frames (metal exposed to touch) are always grounded.

SunEvo recommends always refer to local state and national code requirements for PV module grounding. SunEvo highly recommends negative grounding if it's allowed by local authorities.

When attaching the frame grounding hardware and wire to the frame it must be placed corresponding to the ground symbol stamped location to ensure proper electrical connection.

SunEvo recommends one of the following parts for grounding:

- 1) Use M5 bolt and washer to bond the ground wire and aluminum frame through the grounding hole (as shown below). The tightening torque is 3-7Nm. All nuts and washers should be made of stainless steel. 4-14 mm² (AWG 6-12) exposed copper wire recommended as ground wire.

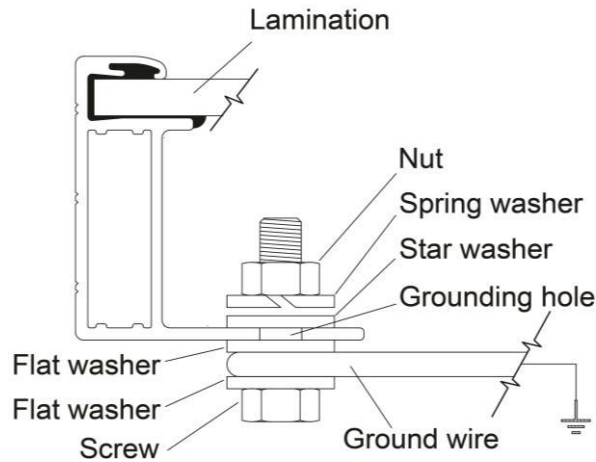

2) Use WEEB-DPF to bond solar modules to module mounting brackets (grounding part is tested to UL467)

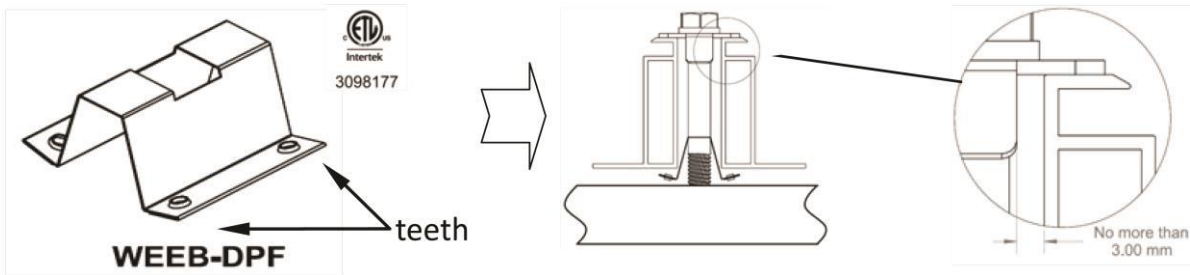

Notice that WEEB tooth is positioned completely under the edge of the module frame. When position of solar module is finalized, torque fasteners to 20.5 N-m/15 ft-lb using general purpose anti-seize on threads.

For more information, please contact supplier: BURNDY, <http://www.we-llc.com>

3) Use Schletter clamps to bond solar module to module mounting brackets (grounding part is tested to UL467).

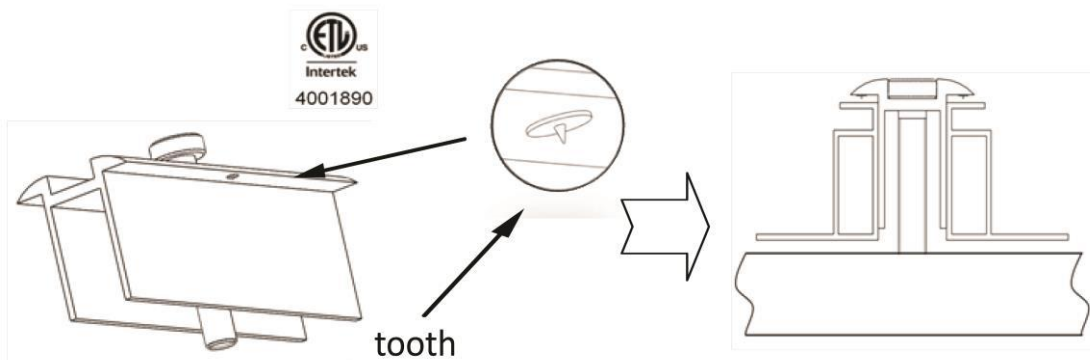

Recommend fastening torque is 20.5N-m/15 ft-lb.

Maintenance

To ensure optimum module performance, SunEvo recommends the following maintenance measures:

Clean the module minimum once a year or more often when required depending of the pollution. Remove

all organic from the surface. Module with soiling or contamination may reduce the power generation of the system. Always use clean water and a soft non-abrasive sponge or cloth for cleaning. A mild, non-abrasive cleaning agent may be used to remove stubborn dirt.

Uncontrolled pollution is voiding the warranty or not cleaning the modules in time voids the warranty.

Check the electrical, grounding and mechanical connections every six months to verify that they are clean, secure, undamaged and free of corrosion. Or else the warranty may be voided.

In the event of a ground fault condition, NEVER wash or spray modules with water until ground fault has been identified, corrected by an authorized solar inverter service technician and the inverter is fully operational. This can cause electrocution or a serious safety issue.

If any problem arises, consult a professional solar service provider for suggestions.

Caution: observe solar manufacturers' maintenance instructions for all components used in the system, such as support frames, charging regulators, inverters, batteries etc.

SunEvo Solar Co., Ltd.

Tel: +86 551 6262 4885

E-mail: info@sunevo.com

Web: www.sunevo.com

Address: No. 398 Ganquan Road, Hefei, Anhui, China.